



VIGOLO

LOW BODY MULCHERS





SCAN TO SEE
IT IN ACTION





vigolo.com



Armour Group

(02) 4862 9080

21 Brookdale Rd, Moss Vale

NSW 2577 Australia

sales@armourgroup.com.au

We reserve the right to make alterations without prior notice. The data given in this booklet refers to standard machines. Photographs and drawings of this booklet don't always reflect CE regulations.

Contents

Welcome to Vigolo by Armour Group	04
Low Body Range	05
Equipped for work	06
Unrivalled Durability	08
Behind the Design	10
Featured Accessories	11
TK2 100 - 200	12
MU2 100 - 250	13
TSA/P 180 - 300	14
TSA/PR 180 - 300	15
RSA Max Series	16
RSA Max 180 - 320	17
RSA/R Max 180 - 320	18
RSA Pick-Up 160-250	19
TK Hydro 120-180	20
Tools and Accessories	21
Model comparison chart	22







Welcome to Vigolo by Armour Group



Explore the work-hardened capability of Vigolo - part of Armour Group's vast range of tankers, pumps, trailers, mulchers, spreaders, feed mixers, seeders, and ATV and farm tractor attachment solutions.

Vigolo, the Italian-built range of Mulchers with a proud 60-year history have a tried and true reputation with Aussie farmers, contractors and councils.

Today, Armour Group distributes and supports Vigolo's premium range of Subsoilers, Rotary Hoes, Harrows, Hole Diggers, Seedbed Cultivators and High and Low Body Mulchers.

Model Suitability						
SERIES	 PARKS	 GARDENS	 VINEYARDS	 ORCHARDS	 FALLOW	 HP REQUIRED
TK2	●	●	●	●		25 - 80
MU2	●	●	●	●	●	25 - 100
TSA/P - TSA/PR	●	●	●	●	●	50 - 80
RSA MAX - RSA/R MAX	●	●	●	●	●	40 - 180
RSA PICK-UP	●	●	●	●	●	40 - 160
TK HYDRO	●	●	●	●		Hydraulic

Every Vigolo machine is built to put in a hard day's effort. All units have been developed, designed and tested in Australia to meet the rigours of Australian conditions and comply with all applicable safety regulations.

TK2 100 - 200

25 - 80 HP



MU2 100 - 250

25 - 100 HP

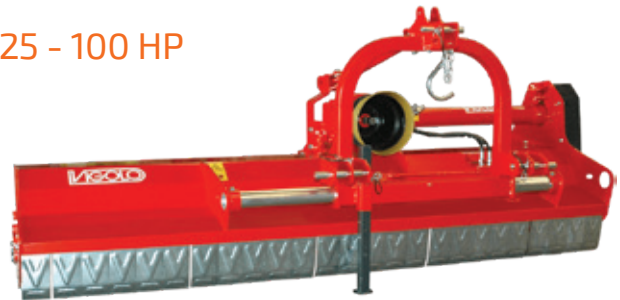

TSA/P 180 - 300

50 - 180 HP



TSA/PR 180 - 300

Reversible
Mulcher



RSA Max 180 - 320

40 - 180 HP



RSA/R Max 180 - 320

Reversible
Mulcher



RSA Pick-Up 160 - 250

40 - 160 HP



TK Hydro 120 - 180

Hydraulic



Behind the design



Designed for getting up close to trees and fence lines, Vigolo Low Body Mulchers are ideal for mulching undergrowth, pruning clippings from orchards & vineyards, pasture & vegetable topping, and roadside applications.

Solid heavy-duty construction with flexible front and rear tractor linkage mount operation with a manual or hydraulic offset side shift

Vigolo headstocks are built to last in every work condition, even under continuous strain.



RSA Headstock

Manual side shift

Hydraulic side shift

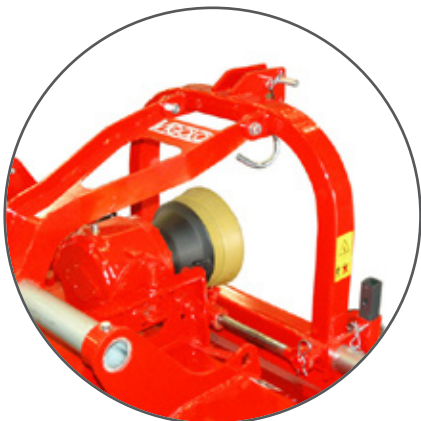

Power transmission

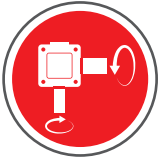

All Vigolo low body mulchers are equipped with free wheel in gearbox so that on disengaging the PTO, the mulching rotor winds down without driving through the gear box and PTO drive shaft.

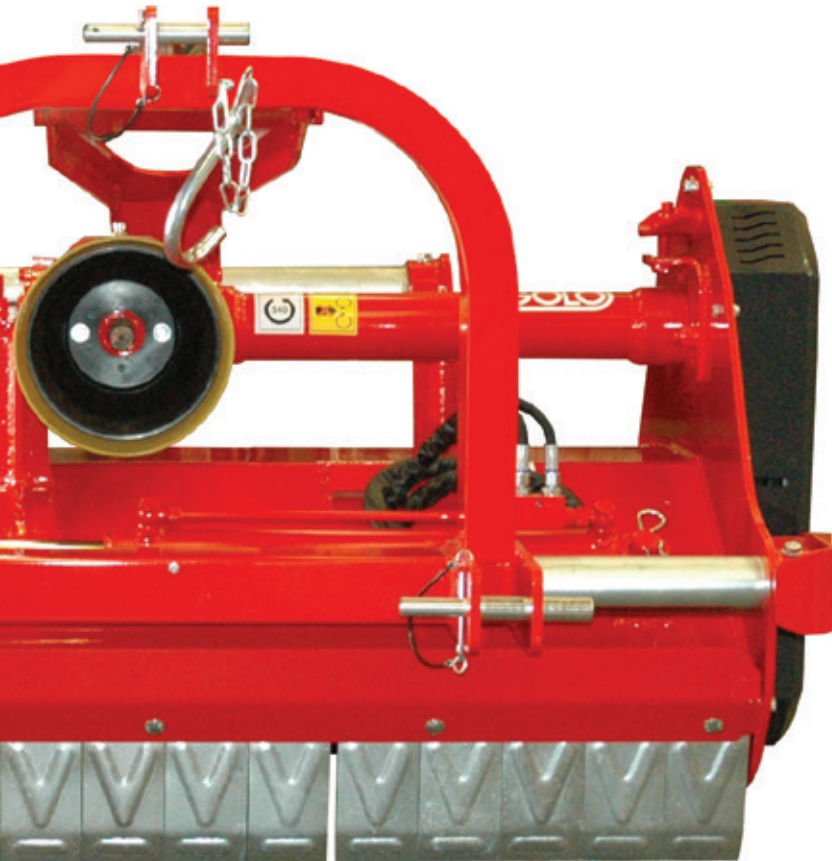

Frame and rotor



Vigolo low body mulchers excel in demanding conditions, with performance benefiting from the wide rotor diameter. With double hood liner as standard, Vigolo low body mulchers allows optimal mulching in any environment and on any material.

TSA/P double headstock with double PTO



TSA/P Headstock with single PTO



Front headstock with double PTO



Unrivalled Durability

Side skids



Optional side skids protect the mulcher body and work in tandem with the rear roller to navigate uneven ground and enhance machine stability for the most demanding work.

Skid with lower plate



Skid without lower plate



Front protection

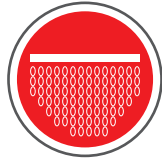

Vigolo low body mulchers include front flap protection; creating a safe barrier which assists with discharge. Our customers can select chains as an alternative protective discharge barrier.



Flaps

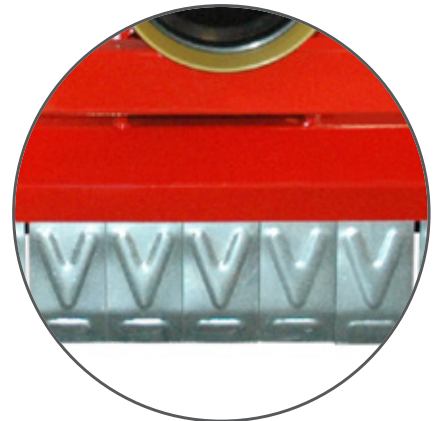

Chains

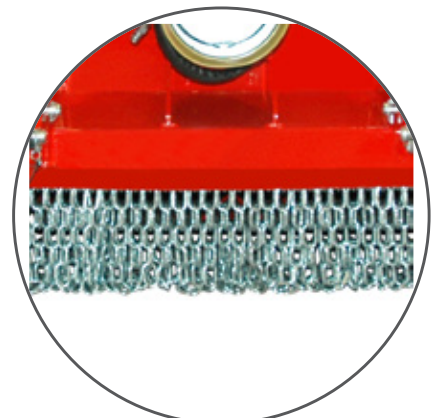

Simplified operation



With unmatched engineering expertise, Vigolo has developed a solid and reliable side transmission design. Easily carry out tension adjustments via screws outside the crankcase; allowing better transmission efficiency and reduced belt wear. By inverting the position of the pulleys, units can be adjusted to 540 rpm or 1000 rpm.

Belt tension adjustment



540 rpm or 1000 rpm

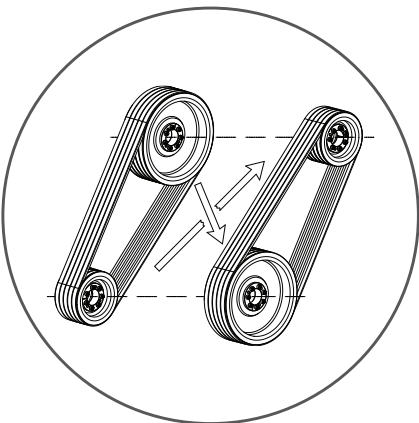

Optional Single or Double Disc Cutter

A range of accessories for your low body mulchers are available. The optional single or double disc cutter allows below ground cutting. Disc cutters can assist with thinning an area in no time. After cutting your area the disc cutter can assist with mulching up cut material, and grounding down stumps flush with the surface.

Available in 600mm diameter with spring return / hydraulic connection with tank, radiator and hydraulic closing system included. Suitable for models TSA/P and RSA MAX.

Single hydraulic disc cutter



Branch pick-up brush

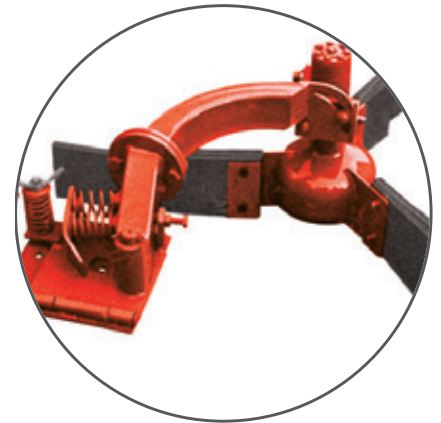

Double hydraulic disc cutter



Spring return



TK2 100 - 200



25 - 80 HP



Standard Equipment

- Cat 1, 3 point linkage
- Manual side shift
- Gearbox with free wheel - 540 PTO rpm
- PTO drive shaft (1" 3/8 - 6 Spline)
- Rear roller adjustable in height with scraper
- Closed mulching chamber
- Front protection flaps
- EC guard kit
- Side skids



Front version available

Profi Version

- Double skinned body
- Opening rear door

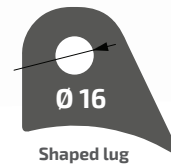
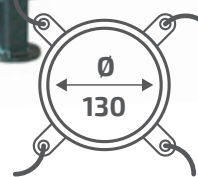

MODEL	WORKING WIDTH	TRANSPORT WIDTH	HP MIN - MAX	Kg					
TK2 120	1200	1325	25-80	260	14	40	± 125	2	
TK2 140	1400	1525	30-80	290	16	48	± 125	3	
TK2 160	1600	1725	30-80	320	18	56	± 125	3	
TK2 180	1800	1925	40-80	350	20	60	± 125	4	
TK2 200	2000	2125	40-80	370	22	64	± 125	4	

INDENT ORDER

TK2 100	1000	1125	35-80	240	12	35	± 125	2	
TK2 150	1500	1625	30-80	300	16	52	± 125	3	

MU2 100 - 250



25 - 100 HP



Standard Equipment

- Cat 1, 3 point linkage (MU2 100/140)
- Cat 2, 3 point linkage (MU2 150/250)
- Manual side shift
- Gearbox with free wheel - 540 PTO
- 540/1000 PTO (By inverting pulleys)
- PTO drive shaft (1¹/₈ - 6 Spline)
- Double counter-knife
- Rear roller adjustable in height with scraper
- Closed mulching chamber
- Front protection flaps
- EC guard kit
- Side skirts



Front version available

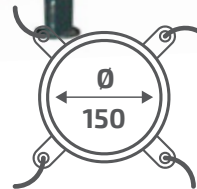
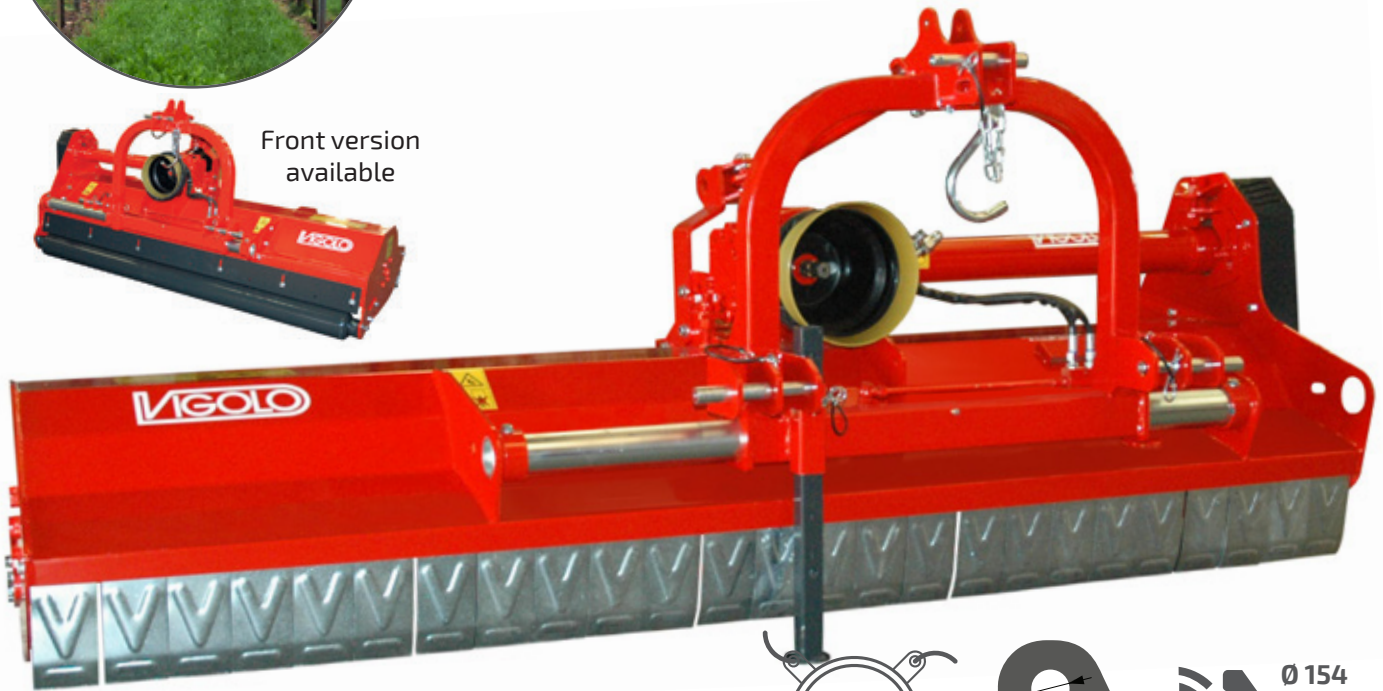

MODEL	WORKING WIDTH	TRANSPORT WIDTH	HP MIN - MAX	Kg					
-------	---------------	-----------------	--------------	----	--	--	--	--	--

MU2 160	1600	1740	40-100	470	14	36	± 200	3	
MU2 180	1800	1970	40-100	505	16	40	± 250	4	
MU2 200	2000	2170	40-100	530	18	44	± 250	4	
MU2 220	2200	3770	50-100	600	20	48	± 250	4	
MU2 250	2500	2670	60-100	660	22	56	± 250	5	

INDENT ORDER

MU2 100	1000	1110	25-100	355	8	24	± 125	2	
MU2 120	1200	1310	30-100	400	10	28	± 125	2	
MU2 140	1400	1510	30-100	420	12	32	± 125	3	
MU2 150	1500	1640	40-100	450	14	36	± 200	3	



TSA/P 180 - 300









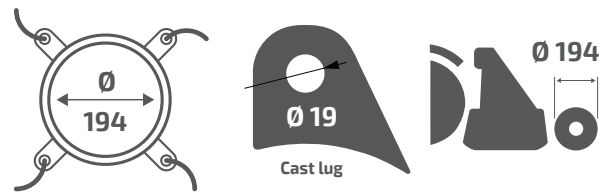

50 - 180 HP

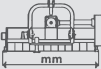
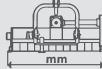

Standard Equipment

- Cat 2, 3 point linkage
- Manual side shift
- Gearbox with free wheel
- 540 PTO (TSA/P 180/250)
- Gearbox with free wheel
- 1000 PTO (TSA/P 280/300)
- 540/1000 PTO
(By inverting pulleys)
- PTO drive shaft 1 3/8" x 6 Spline
- Triple counter-knife
- Rear roller adjustable in height with scraper, heavy duty bearings
- Opening rear door
- Provision for branch pick-up spikes
- Front protection flaps
- EC guard kit
- Side Skids



MODEL	 WORKING WIDTH	 TRANSPORT WIDTH	 HP MIN - MAX	 Kg					
TSA/P 180	1800	1970	50-120	650	40	34	± 200	5	
TSA/P 200	2000	2170	50-120	700	44	38	± 200	5	
TSA/P 220	2200	2370	50-120	760	48	40	± 200	5	
TSA/P 250	2500	2670	60-120	830	56	48	± 200	5	
TSA/P 280	2800	2990	70-180	910	64	52	± 200	6	
TSA/P 300	3000	3190	80-180	1000	68	56	± 200	6	

TSA/PR 180 - 300











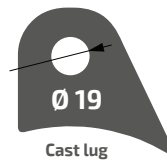
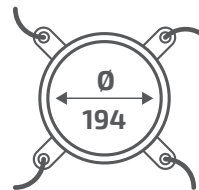
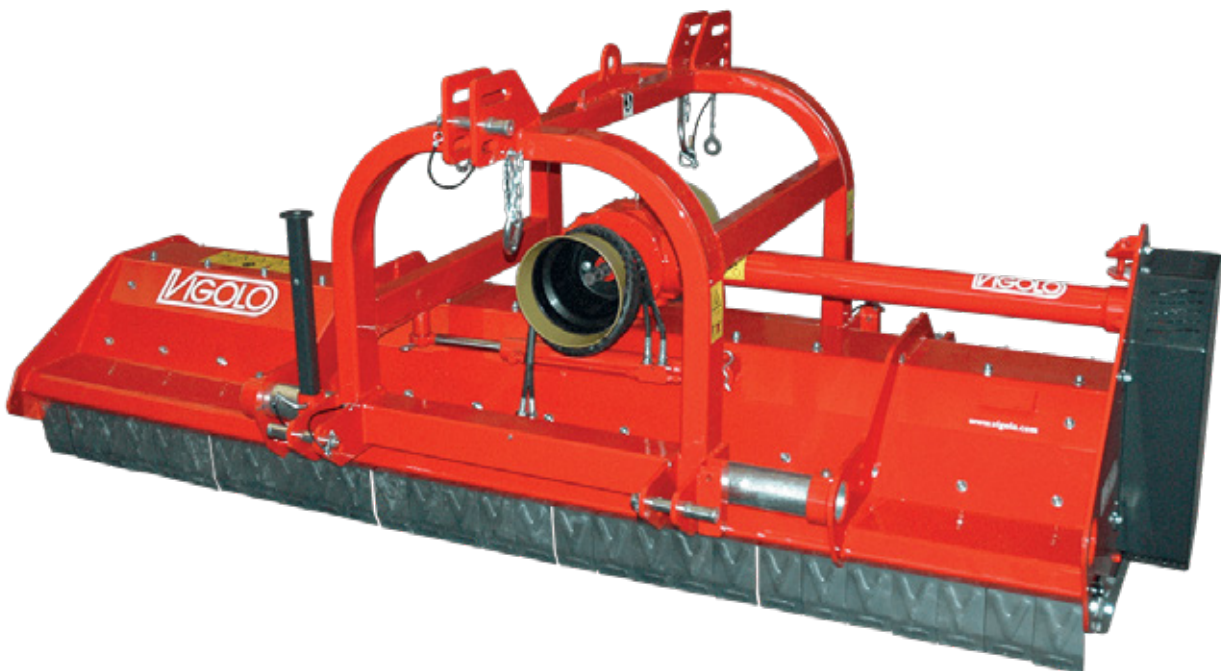

Reversible Mulcher



Standard Equipment

- Cat 2, 3 point linkage
- Hydraulic side shift
- Double sided headstock for front and rear tractor linkage
- Gearbox with free wheel - 1000 PTO
- 540/1000 PTO (By inverting pulleys)
- PTO drive shaft 1 3/8" x 6 Spline
- Triple counter-knife
- Rear roller adjustable in height with scraper, heavy duty bearings
- Closed mulching chamber
- Provision for branch pick-up spikes
- Front protection flaps
- EC guard kit
- Side Skids



MODEL	 WORKING WIDTH	 TRANSPORT WIDTH	 HP MIN - MAX	 Kg					
TSA/PR 180	1800	1970	50-120	650	40	34	± 200	5	
TSA/PR 220	2200	2370	50-120	760	48	40	± 200	5	
INDENT ORDER									
TSA/PR 200	2000	2170	50-120	700	44	38	± 200	5	
TSA/PR 250	2500	2670	60-120	830	56	48	± 200	5	
TSA/PR 280	2800	2990	70-180	910	64	52	± 200	6	
TSA/PR 300	3000	3190	80-180	1000	68	56	± 200	6	





Heavy duty professional mulcher

Vigolo RSA MAX series mulchers are heavy-duty, multi-purpose machines ideal for vineyard and orchard mulching, and for roadside mulching by municipal bodies and contractors.

Optional tree guard and branch pickup spikes protect stems and trunks and shred plant residue precisely.

Our TSA/L model is also available also in a lower set version.

Tree guard



'Tree guard brackets



Branch pick-up spikes



Lower set version

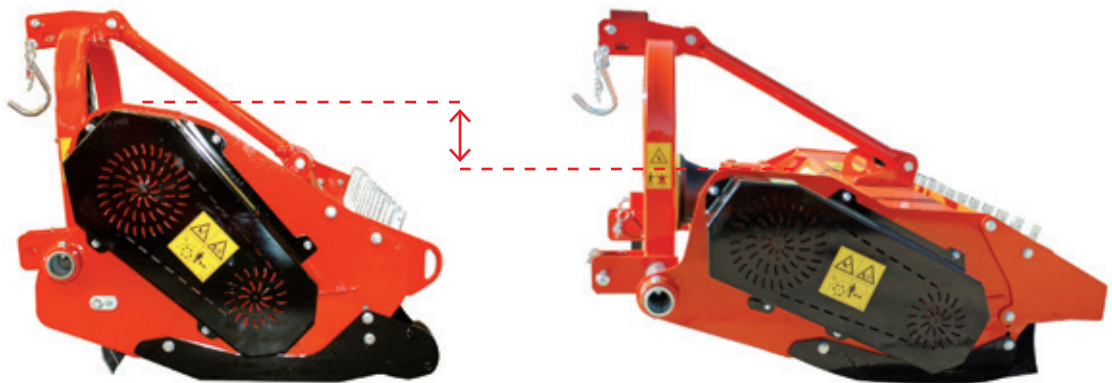

RSA Max 180 - 320



60 - 180 HP



Standard Equipment

- Cat 2, heavy duty 3 point linkage
- Double tube headstock with hydraulic side shift
- Gearbox with free wheel - 540 PTO (RSA MAX 180/250)
- Gearbox with free wheel - 1000 PTO (RSA MAX 280/320)
- 540/1000 PTO (By inverting pulleys)
- PTO drive shaft 1 3/8" x 6 Spline
- Reinforced double skin body
- Triple counter-knife
- Rear roller adjustable in height with scraper, heavy duty bearings
- Front rounded body shape with flattened side
- Opening rear door
- Provision for branch pick-up spikes
- Front protection chains
- EC guard kit
- Side Skids



Rounded Side

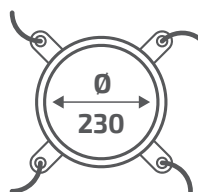

MODEL	WORKING WIDTH mm	TRANSPORT WIDTH mm	HP MIN - MAX	Kg					
RSA MAX 180	1800	1990	60-120	790	16	32 + 16	± 250	5	
RSA MAX 200	2000	2190	70-120	840	18	36 + 18	± 250	5	
RSA MAX 220	2200	2390	70-120	910	20	40 + 20	± 250	5	
RSA MAX 250	2500	2690	80-120	980	22	44 + 22	± 250	5	
RSA MAX 280	2800	2990	90 - 180	1050	24	48 + 24	± 250	6	
RSA MAX 300	3000	3190	100 - 180	1120	28	56 + 28	± 250	6	
RSA MAX 320	3200	3390	100 - 180	1150	32	64 + 32	± 250	6	





Standard Equipment

- Cat 2, heavy duty 3 point linkage
- Double tube headstock with hydraulic side shift
- Double sided headstock for front and rear tractor linkage
- Gearbox with free wheel - 1000 PTO
- 540/1000 PTO (By inverting pulleys)
- PTO drive shaft 1 3/8" x 6 Spline
- Reinforced double skin body
- Triple counter-knife
- Rear roller adjustable in height with scraper, heavy duty bearings
- Front rounded body shape with flattened side
- Closed Mulching Chamber
- Provision for branch pick-up spikes
- Front protection chains
- EC guard kit
- Side Skids



Rounded Side

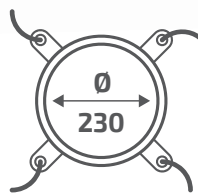

MODEL	WORKING WIDTH	TRANSPORT WIDTH	HP MIN - MAX	Kg					
RSA/R MAX 220	2200	2390	100 - 120	960	20	40 + 20	± 200	5	
INDENT ORDER									
RSA/R MAX 180	1800	1990	80 - 120	840	16	32 + 16	± 200	5	
RSA/R MAX 200	2000	2190	90 - 120	840	18	36 + 18	± 200	5	
RSA/R MAX 250	2500	2690	100 - 120	1030	22	44 + 22	± 200	5	
RSA/R MAX 280	2800	2990	100 - 180	1100	24	48 + 24	± 200	6	
RSA/R MAX 300	3000	3190	120 - 180	1170	28	56 + 28	± 200	6	
RSA/R MAX 320	3200	3390	120 - 180	1200	32	64 + 32	± 200	6	

RSA Pick-Up 160-250









40 - 160 HP

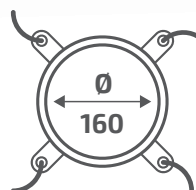

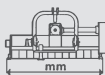
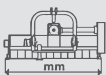
Standard Equipment

- Cat 2, 3 point linkage
- Manual side shift
- Gearbox with free wheel - 540 PTO
- 540/ 1000 PTO (By inverting pulleys)
- PTO drive shaft 1 3/8" x 6 Spline
- Reinforced double skin body
- Triple counter-knife
- Rear roller adjustable in height with scraper, heavy duty bearings
- Hydraulic opening rear hopper
- Front protection flaps
- EC guard kit

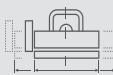

MODEL	 WORKING WIDTH	 TRANSPORT WIDTH	 HP MIN - MAX	 Kg				
INDENT ORDER								
RSA PICK-UP 160	1600	1770	40 - 160	740	14	± 200	5	
RSA PICK-UP 180	1800	1970	40 - 160	900	16	± 200	5	
RSA PICK-UP 200	2000	2170	50 - 160	1060	18	± 200	5	
RSA PICK-UP 220	2200	2370	50 - 160	1120	20	± 200	5	
RSA PICK-UP 250	2500	2670	60 - 160	1380	22	± 200	5	



TK Hydro 120-180









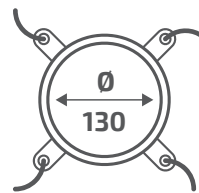

Hydraulic Transmission



Standard Equipment

- Quicke/Trima SMS (Category 5) tractor loader quick hitch
- Hydraulic transmission
- Arrangement for oil flow 40-50 lt/min
- Rear roller adjustable in position with scraper or self-cleaning
- Front protection flaps
- EC guard kit



MODEL	 WORKING WIDTH	 TRANSPORT WIDTH	 Kg				
INDENT ORDER							
TK HYDRO 120	1200	1325	320	14	40	2	
TK HYDRO 140	1400	1525	350	16	48	2	
TK HYDRO 160	1600	1725	380	18	56	3	
TK HYDRO 180	1800	1925	420	20	60	3	

TOOL	DESCRIPTION	TK2	TSA	RSA	TOOL	DESCRIPTION	TK2	TSA	RSA
Hammer		●	-	-	Hammer		-	-	●
Hammer		-	●	-	Knives with central small hammer		-	-	○
Y Knife		○	○	-					

● Standard ○ Optional - Not available



Steel Front Wheels



Rear Rubber Wheels



Hydraulic Side Shift



Road Table Kit











Tree guard brackets



Branch Pick-up Spikes

Model comparison chart

CAT.	MODEL	 WORKING WIDTH	 TRANSPORT WIDTH		 HP MIN - MAX	 Kg	 3PL CATEGORY	 540 RPM	 1000 RPM	 BELTS
TK2	TK2 100	1000	1125	± 125	25-80	240	1°	2590	2500	2
	TK2 120	1200	1325	± 125	25-80	260	1°	2590	2500	2
	TK2 140	1400	1525	± 125	30-80	290	1°	2590	2500	3
	TK2 150	1500	1625	± 125	30-80	300	1°	2590	2500	3
	TK2 160	1600	1725	± 125	30-80	320	1°	2590	2500	3
	TK2 180	1800	1925	± 125	40-80	350	1°	2590	2500	4
	TK2 200	2000	2125	± 125	40-80	370	1°	2590	2500	4
MU2	MU2 100	1000	1110	± 125	25-100	355	1°	2280	2140	2
	MU2 120	1200	1310	± 125	30-100	400	1°	2280	2140	2
	MU2 140	1400	1510	± 125	30-100	420	1°	2280	2140	3
	MU2 150	1500	1640	± 200	40-100	450	1° / 2°	2280	2140	3
	MU2 160	1600	1740	± 200	40-100	470	1° / 2°	2280	2140	3
	MU2 180	1800	1970	± 250	40-100	505	1° / 2°	2280	2140	4
	MU2 200	2000	2170	± 250	40-100	530	1° / 2°	2280	2140	4
	MU2 220	2200	2370	± 250	50-100	600	1° / 2°	2280	2140	4
TSA/P & REVERSE	TSA/P 180	1800	1970	± 200	50-120	650	2°	2280	2140	5
	TSA/P 200	2000	2170	± 200	50-120	700	2°	2280	2140	5
	TSA/P 220	2200	2370	± 200	50-120	760	2°	2280	2140	5
	TSA/P 250	2500	2670	± 200	60-120	830	2°	2280	2140	5
	TSA/P 280	2800	2990	± 200	70-180	910	2°	2280	2140	6
	TSA/P 300	3000	3190	± 200	80-180	1000	2°	2280	2140	6
RSA MAX & REVERSE	RSA MAX 180	1800	1990	± 250	80-120	790	2°	2280	2140	5
	RSA MAX 200	2000	2190	± 250	90-120	840	2°	2280	2140	5
	RSA MAX 220	2200	2390	± 250	100-120	910	2°	2280	2140	5
	RSA MAX 250	2500	2690	± 250	100-120	980	2°	2280	2140	5
	RSA MAX 280	2800	2990	± 250	100-180	1050	2°	1690	2000	6
	RSA MAX 300	3000	3190	± 250	120-180	1120	2°	1690	2000	6
	RSA MAX 320	3200	3390	± 250	120-180	1150	2°	1890	1780	6
RSA PICK-UP	RSA PICK-UP 160	1600	1770	± 200	40-160	740	2°	2280	2140	5
	RSA PICK-UP 180	1800	1970	± 200	40-160	900	2°	2280	2140	5
	RSA PICK-UP 200	2000	2170	± 200	50-160	1060	2°	2280	2140	5
	RSA PICK-UP 220	2200	2370	± 200	50-160	1220	2°	2280	2140	5
	RSA PICK-UP 250	2500	2670	± 200	60-160	1380	2°	2280	2140	5
TK HYDRO	TK HYDRO 120	1200	1325	-	Hydraulic	320	-	2600	-	2
	TK HYDRO 140	1400	1525	-	Hydraulic	350	-	2600	-	2
	TK HYDRO 160	1600	1725	-	Hydraulic	380	-	2600	-	3
	TK HYDRO 180	1800	1925	-	Hydraulic	420	-	2600	-	3

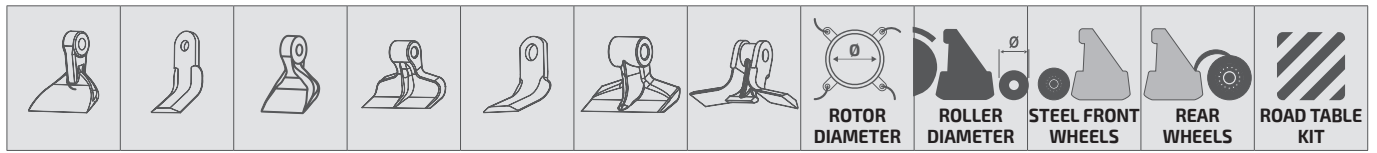

								ROTOR DIAMETER	ROLLER DIAMETER	STEEL FRONT WHEELS	REAR WHEELS	ROAD TABLE KIT
12	32	16	-	-	-	-	130	114	-	-	○	
14	40	20	-	-	-	-	130	114	-	-	○	
16	48	24	-	-	-	-	130	114	○	○	○	
16	52	26	-	-	-	-	130	114	○	○	○	
18	56	28	-	-	-	-	130	114	○	○	○	
20	60	30	-	-	-	-	130	114	○	○	○	
22	64	32	-	-	-	-	130	114	○	○	○	
-	-	18	8	24	-	-	150	154	-	-	○	
-	-	22	10	28	-	-	150	154	-	-	○	
-	-	26	12	32	-	-	150	154	○	○	○	
-	-	28	14	36	-	-	150	154	○	○	○	
-	-	30	14	36	-	-	150	154	○	○	○	
-	-	34	16	40	-	-	150	154	○	○	○	
-	-	38	18	44	-	-	150	154	○	○	○	
-	-	40	20	48	-	-	150	154	○	○	○	
-	-	34	16	40	-	-	194	194	○	○	○	
-	-	38	18	44	-	-	194	194	○	○	○	
-	-	40	20	48	-	-	194	194	○	○	○	
-	-	48	22	56	-	-	194	194	○	○	○	
-	-	52	24	64	-	-	194	194	○	○	○	
-	-	56	28	68	-	-	194	194	○	○	○	
-	-	34	-	-	16	32 + 16	200	194	○	○	○	
-	-	38	-	-	18	36 + 18	200	194	○	○	○	
-	-	40	-	-	20	40 + 20	200	194	○	○	○	
-	-	48	-	-	22	44 + 22	200	194	○	○	○	
-	-	52	-	-	24	48 + 24	200	194	○	○	○	
-	-	56	-	-	28	48 + 28	200	194	○	○	○	
-	-	58	-	-	32	64 + 32	220	194	○	○	○	
-	-	-	-	-	14	-	160	194	○	-	○	
-	-	-	-	-	16	-	160	194	○	-	○	
-	-	-	-	-	18	-	160	194	○	-	○	
-	-	-	-	-	20	-	160	194	○	-	○	
-	-	-	-	-	22	-	160	194	○	-	○	
14	40	20	-	-	-	-	130	114	○	-	○	
16	48	24	-	-	-	-	130	114	○	-	○	
18	56	28	-	-	-	-	130	114	○	-	○	
20	60	30	-	-	-	-	130	114	○	-	○	

○ Optional - Not available





Armour Group

(02) 4862 9080
21 Brookdale Rd, Moss Vale
NSW 2577 Australia
sales@armourgroup.com.au
armourgroup.com.au



July 2022

LOW BODY MULCHERS

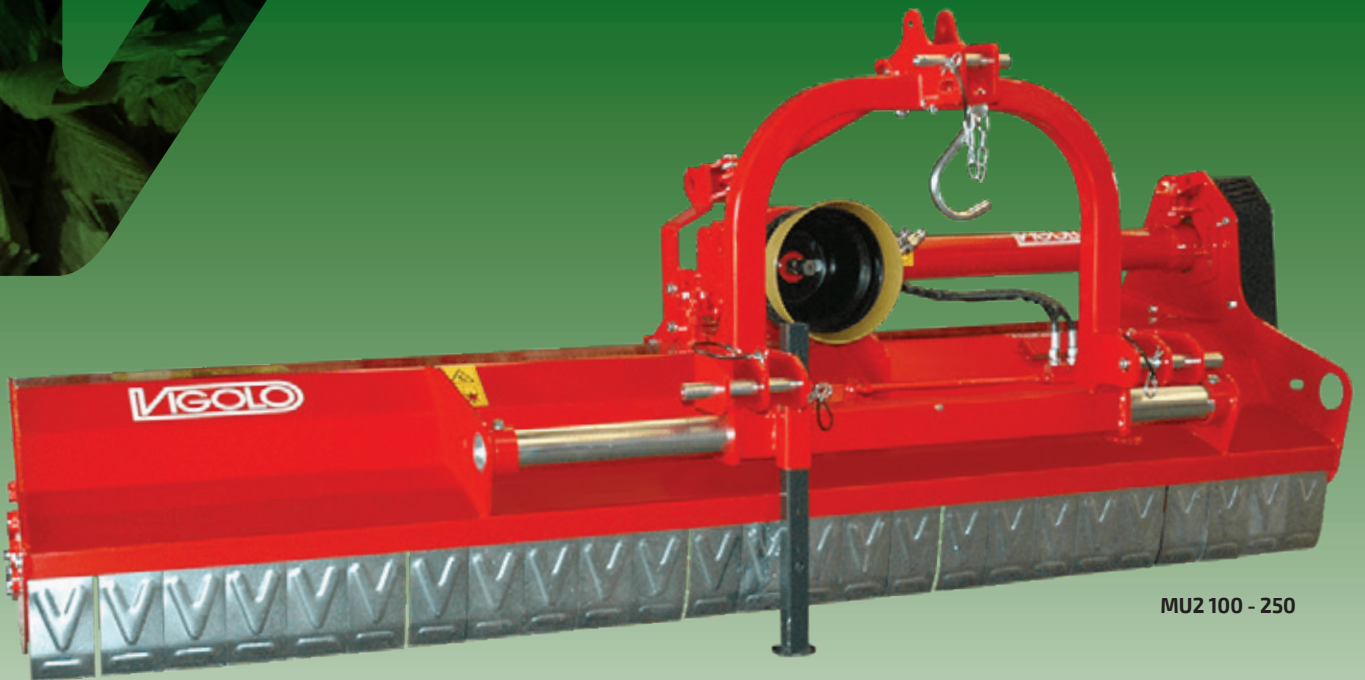

MU2 100 - 250